



Level Intermediate Posts Installation Guide

Look for this sticker
on hardware bags



Tools Needed for Installation



String



Marker

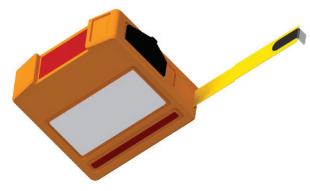

Measuring Tape



Saw



Drill



2.5MM Square Driver Bit



Pliers

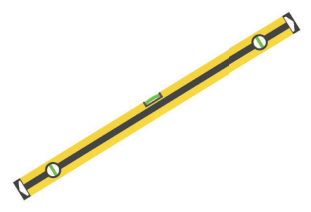

Level

Things to Know Before You Get Started

- Read over the provided material prior to the start of your installation

Visit our YouTube channel to
watch helpful installation videos
youtube.com/viewrail

Level Intermediate Posts Installation Steps

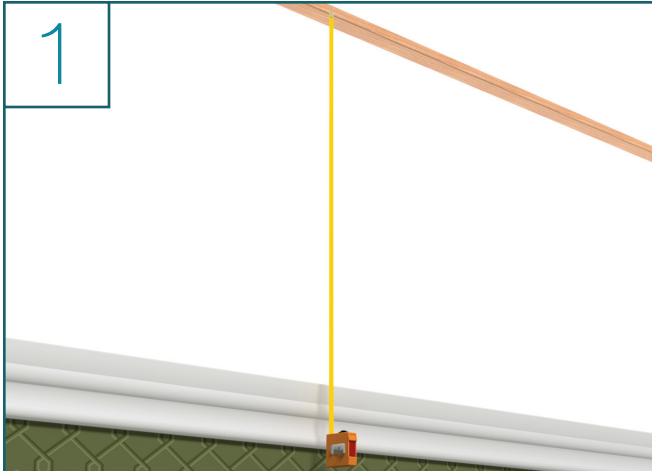

- Using a measuring tape, measure from bottom of handrail to the mounting surface

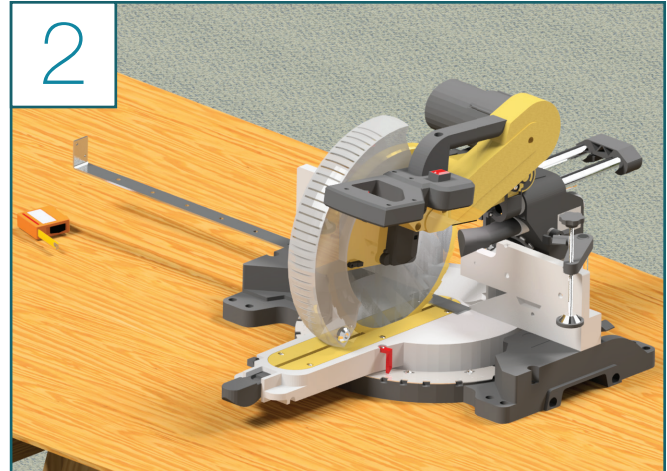

- Cut Intermediate Post to the measurement from the previous step with any device appropriate for cutting stainless steel
- Remove any burrs with a file

Helpful Tip:

At this point, you can use this Intermediate Post as a drilling guide for your wood posts. This will ensure that all of your cable holes line up.



- Slide the Foot Cover then the Intermediate Post Mounting Bracket (Foot) onto the cut end of the Intermediate Post

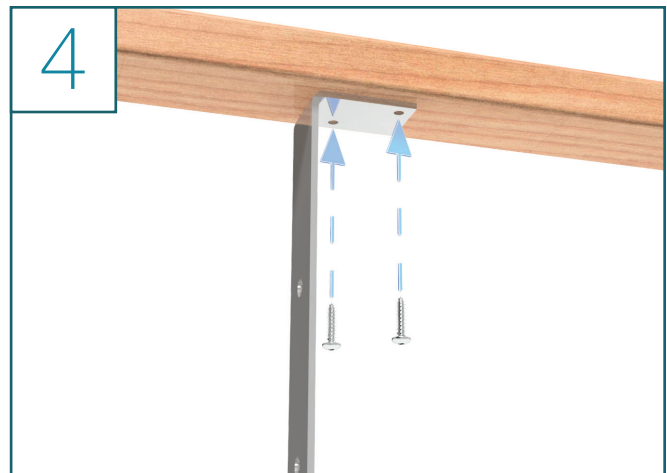

- Mount the top end of the Intermediate Post into the handrail with the provided screws

Level Intermediate Posts Installation Steps (Continued)

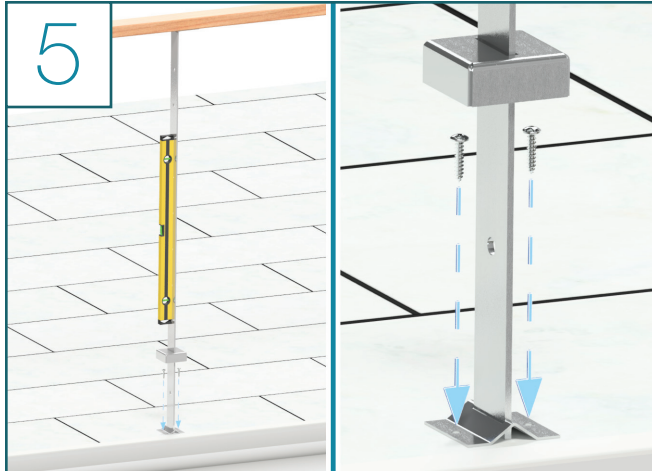

- Make sure the post is vertical, then screw the Intermediate Post Mounting Bracket into the mounting surface with the provided screws

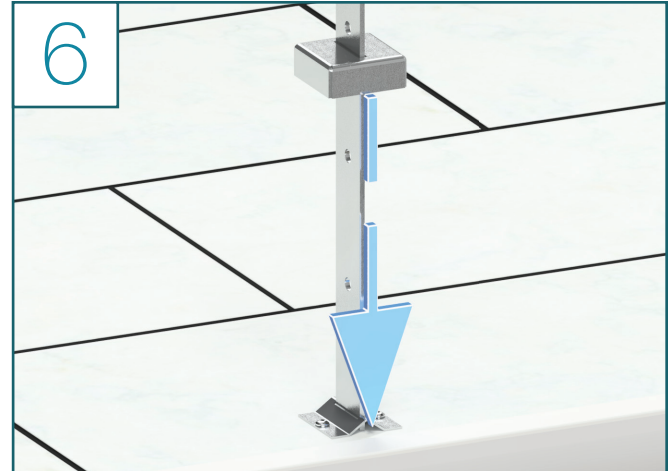

- Slide the Foot Cover over the Intermediate Post Mounting Bracket
- The foot cover can be secured with silicone or epoxy if desired

Congratulations! You're done with this section.

We'd love to see your work! Snap a few pics with your phone and send them to pictures@viewrail.com. Thanks for choosing Viewrail. Enjoy your new installation!



Tools Needed for Installation



String



Marker

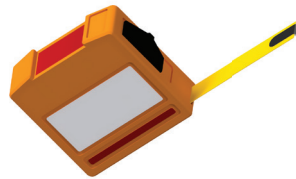

Measuring Tape



Saw



Drill



2.5MM Square Driver Bit



Tool 7

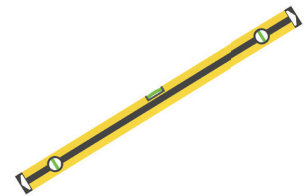

Tool 8

Things to Know Before You Get Started

- Read over the provided material prior to the start of your installation



Angled Intermediate Posts Installation Steps

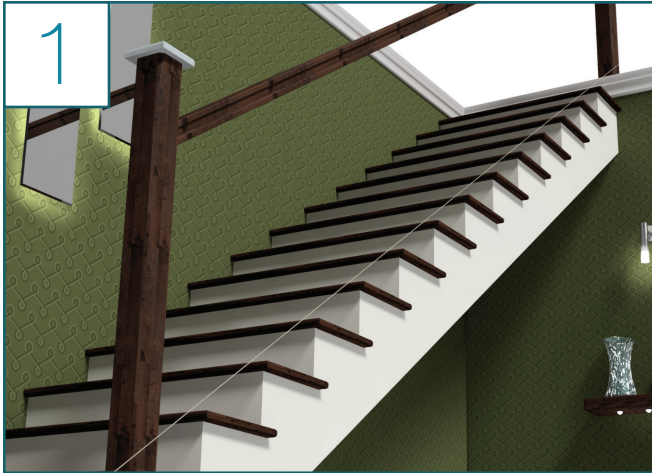

- Run string the length of your angled run to simulate the bottom cable of infill

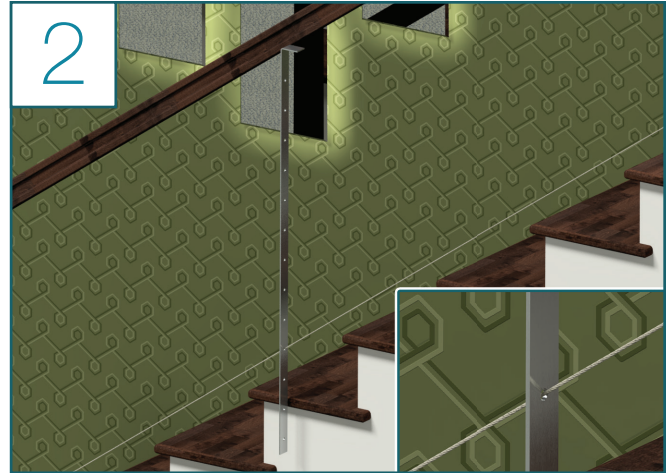

- Hold the Intermediate Post up to the bottom of the handrail with the bottom hanging off the side of the stair

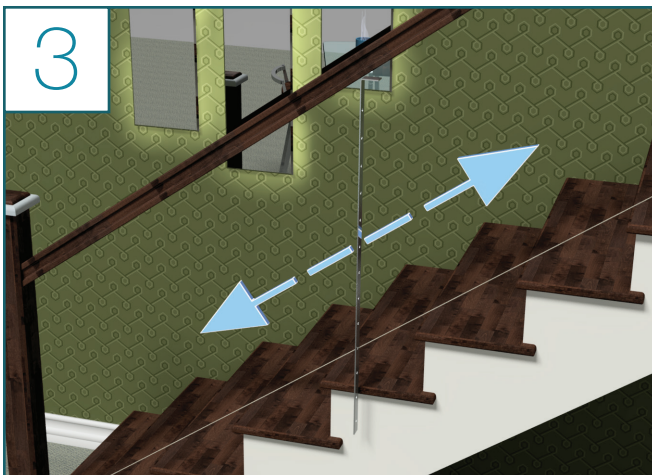

- Slide post to find where a cable hole will line up with your bottom cable (string)



- Once you've found the proper post location, mark the cut length for the post

Angled Intermediate Posts Installation Steps (Continued)

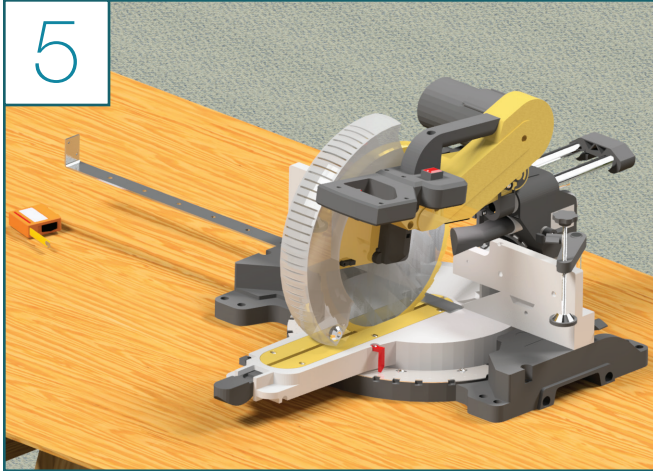

5

- Cut Intermediate Post to the measurement from the previous step with any device appropriate for cutting stainless steel
- Remove any burrs with a file

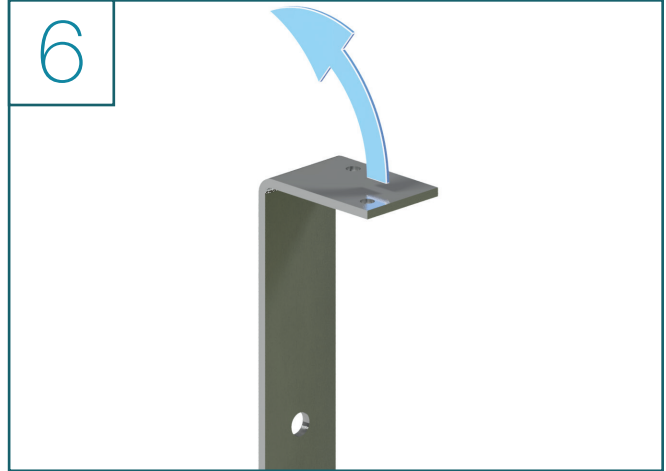

6

- Covering the post top with a rag to protect the finish, use pliers to bend the post top to the appropriate angle



7

- Slide the Foot Cover then the Intermediate Post Mounting Bracket (Foot) onto the cut end of the Intermediate Post

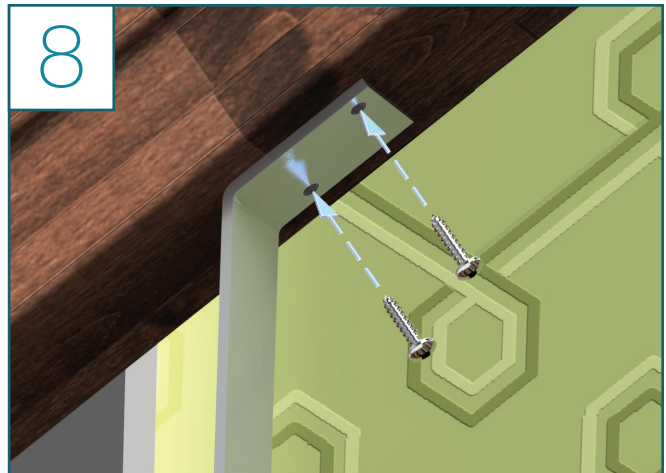

8

- Mount the top end of the Intermediate Post into the handrail with the provided screws

Angled Intermediate Posts Installation Steps (Continued)

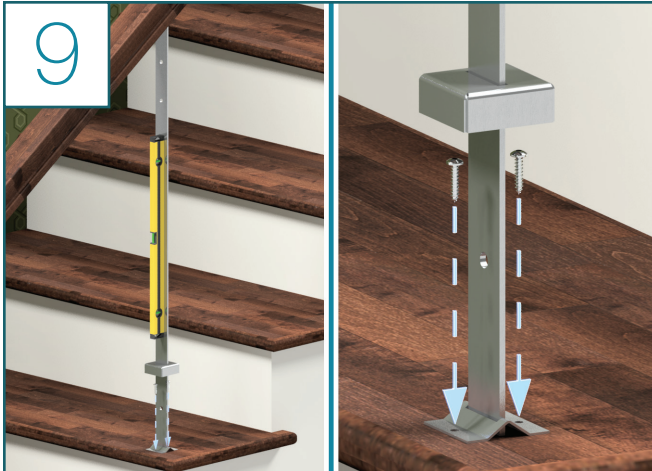

- Make sure the post is vertical, then screw the Intermediate Post Mounting Bracket into the mounting surface with the provided screws

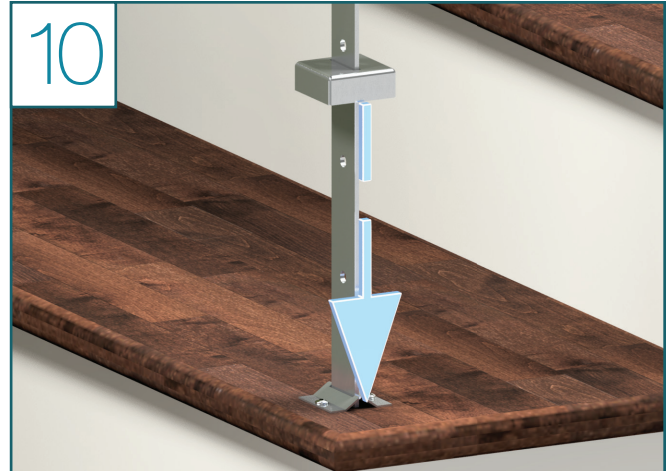

- Slide the Foot Cover over the Intermediate Post Mounting Bracket
- The foot cover can be secured with silicone or epoxy if desired

Congratulations! You're done with this section.

We'd love to see your work! Snap a few pics with your phone and send them to pictures@viewrail.com. Thanks for choosing Viewrail. Enjoy your new installation!