



Tools Needed from the Installation Kit



Torque Wrench



1/2" to 3/8" Reducer



3/4" Socket



5/16" Hex Bit Socket



5/16" Hanger Bolt Driver

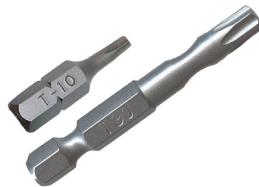

T-10 & T-30 Torx Bits



ThreadLocker



T-30 Torx Socket

Other Tools and Supplies Not Included in the Installation Kit

- Drill/Hammer Drill
- Impact Driver/Socket Wrench
- Pencil
- Level
- T-Square
- 3/8" Wood Drill Bit (*Wood Install Only*)
- 9/16" Concrete Drill Bit (*Concrete Install Only*)
- 11/16" Forstner Bit (*Wood Install Only*)
- Wood Glue
- Concrete Epoxy (*Concrete Install Only*)
- Silicone Sealant

Things to Know Before You Get Started

- Read over the provided material prior to the start of your installation
- Ensure to apply the supplied Threadlocker to all mechanical connections



Straight Hockey Stick Stringer Installation Steps



- Locate the stringers and measure them to make sure they match the prints provided to you during the engineering approval process

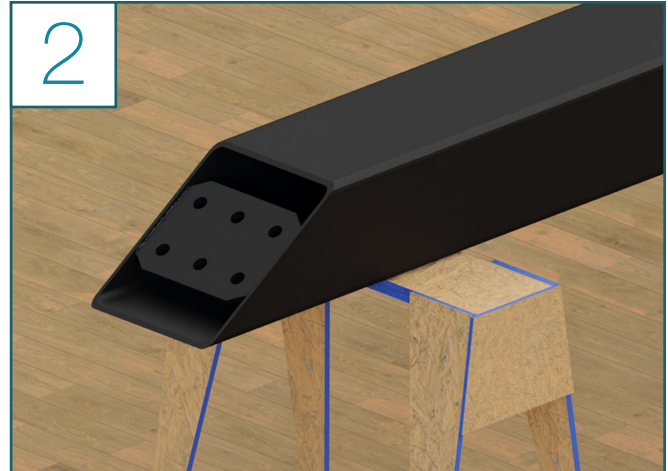

- Locate the stickers that indicate the "Foot" & "Head" sides of the stringer



- Identify and prepare the two halves of the hockey stick

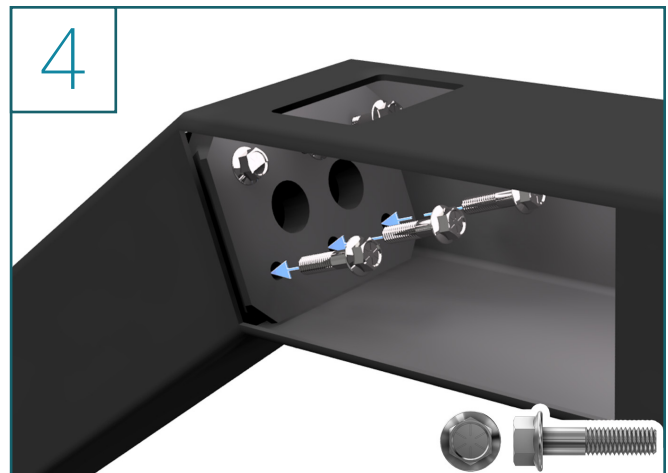

- Using the access hole & the provided 1/2"-13 x 2" bolts, attach the stringer tubes together
- Use a standard wrench at this point to tighten the bolts, but do not over tighten, some adjustability may be needed in following steps

Straight Hockey Stick Stringer Installation Steps (Continued)

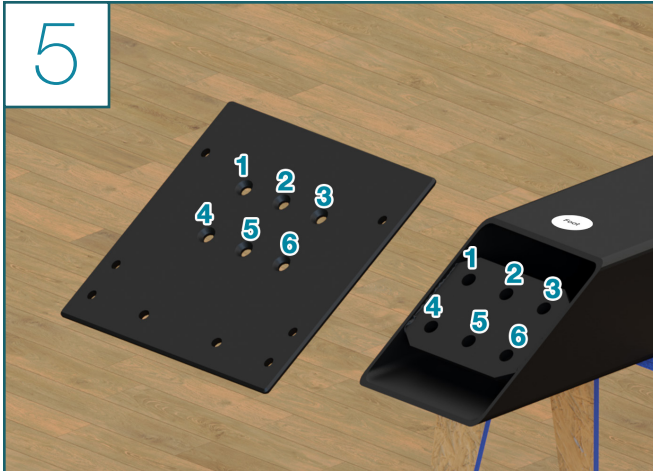

- Noting the “Foot” sticker, match the beveled Foot Plate holes to the Stringer holes

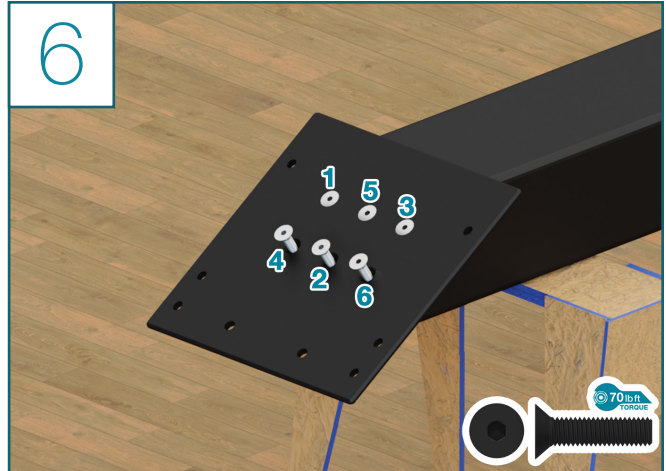

- Use the 1/2" x 2" Flathead Bolts to attach the floor plate to the stringer
- Torque to 70 lb-ft

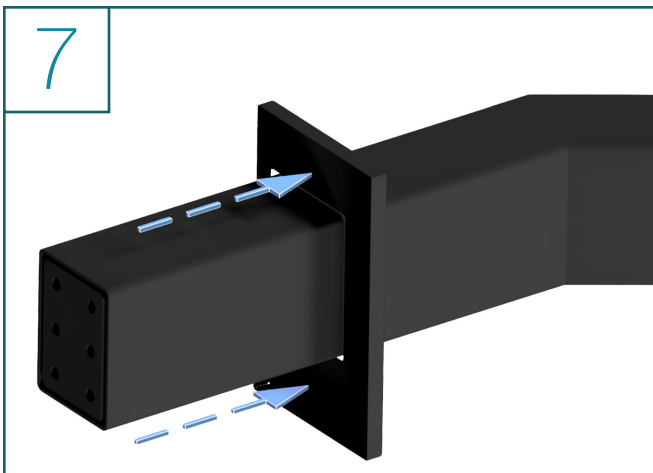

- Slide the cover plate over the stringer, paying attention to its orientation
- The thin section will end up on top of the stringer

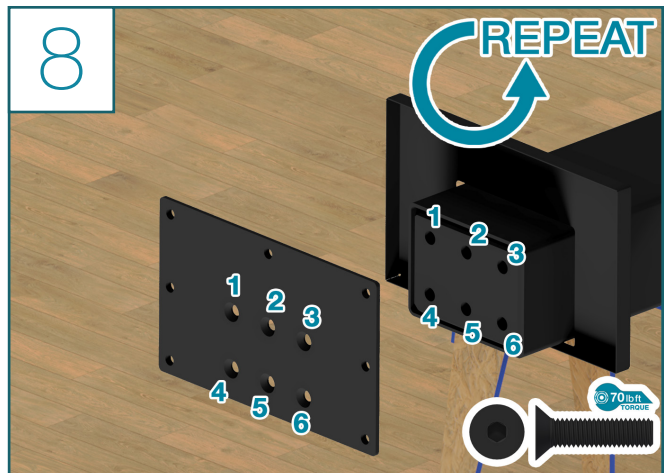

- Noting the “Head” sticker, match the beveled Header Plate holes to the Stringer holes
- Repeat Steps 5-6 for the Header Plate Bolts

Straight Hockey Stick Stringer Installation Steps (Continued)

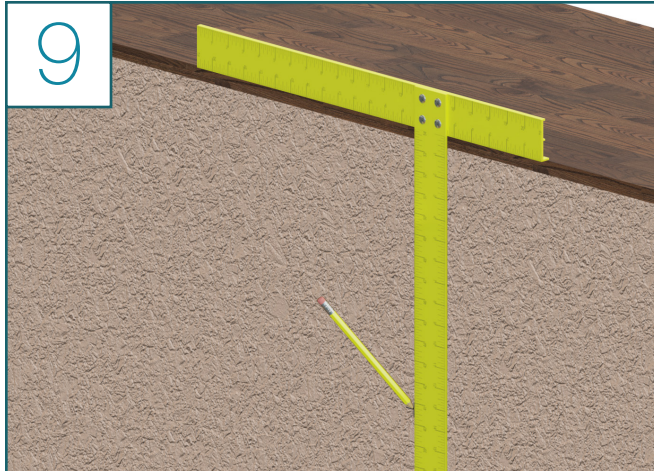

- Use the provided drawing(s) to mark the header plate dimensions
- At this point, mark a predrill location for the slotted hole in your header plate

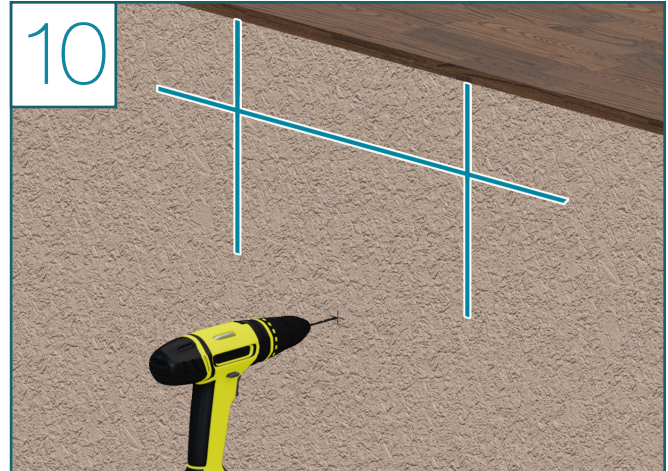

- Predrill with a $\frac{3}{8}$ " drill bit

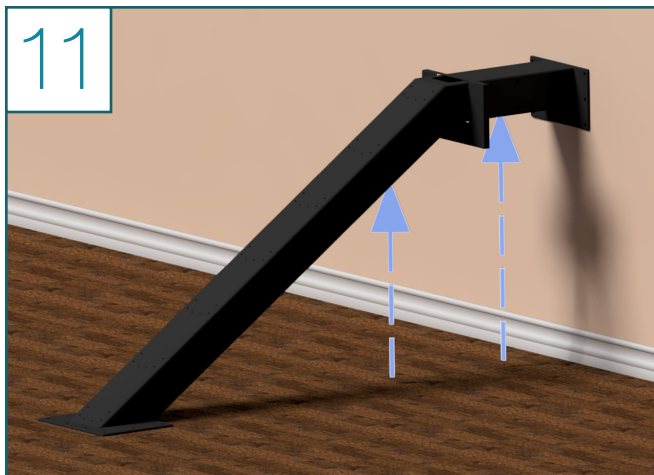

- Lift the stringer into place, lining up the hole

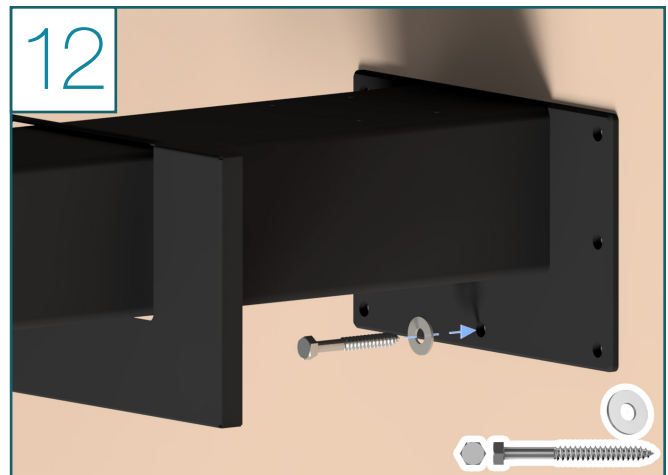

- Fasten the $\frac{1}{2}$ " x $3\frac{1}{2}$ " Hex Lag through the middle slotted hole in the header plate to hold the stringer in place

Straight Hockey Stick Stringer Installation Steps (Continued)

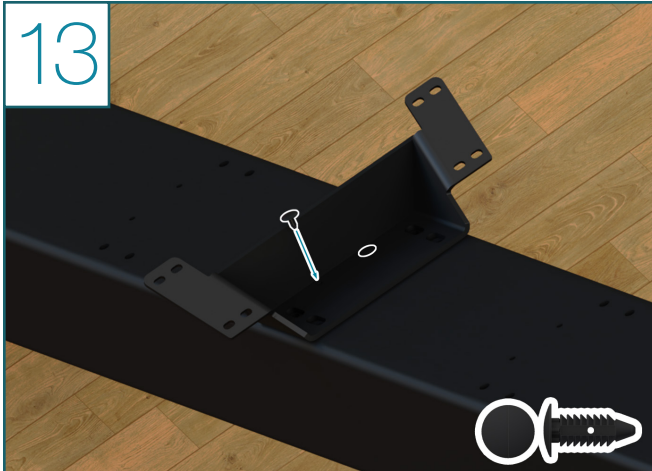

- Place all tread brackets on the lower stringer
- Insert Christmas Tree Rivets to hold the tread brackets in place

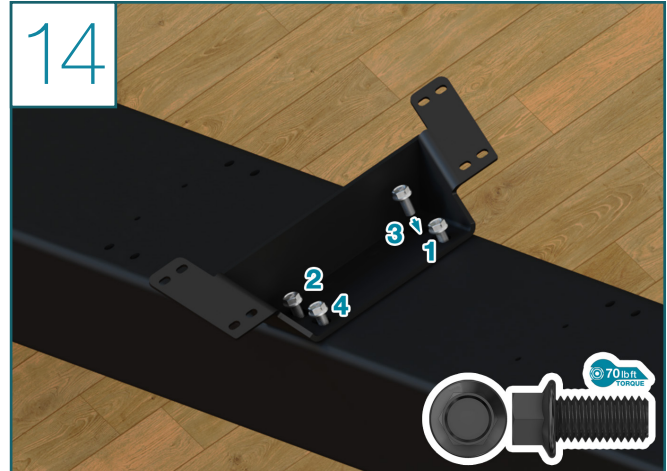

- Thread the 1/2" x 1" flange bolts through the tread bracket into the stringer in the marked order until they are finger tight
- Torque to 70 lb-ft



- Identify one of the middle treads by comparing the labels on the bottom of each to the Wood Install sheet in the front of this packet
- Place a single one of those treads on to one of the tread brackets about half-way up the stringer

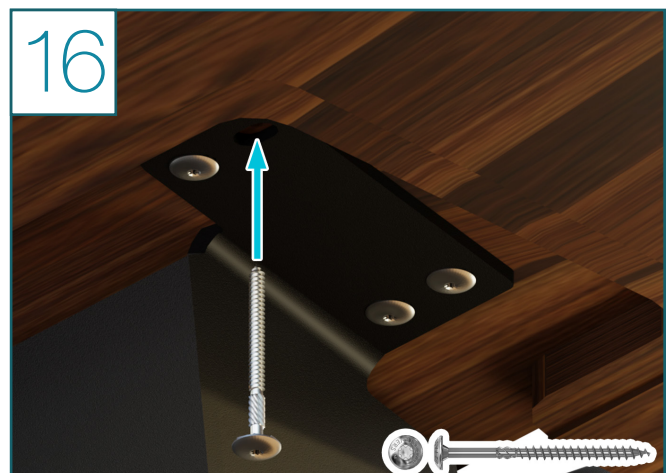

- Using the 5/16" x 2 1/2" RSS Screws, attach the tread to the tread bracket
- During this step, alternate sides of the bracket when fastening screws. This will prevent the tread from pulling unevenly

Straight Hockey Stick Stringer Installation Steps (Continued)



- Ensure the tread is level on the tread bracket both front to back and left to right

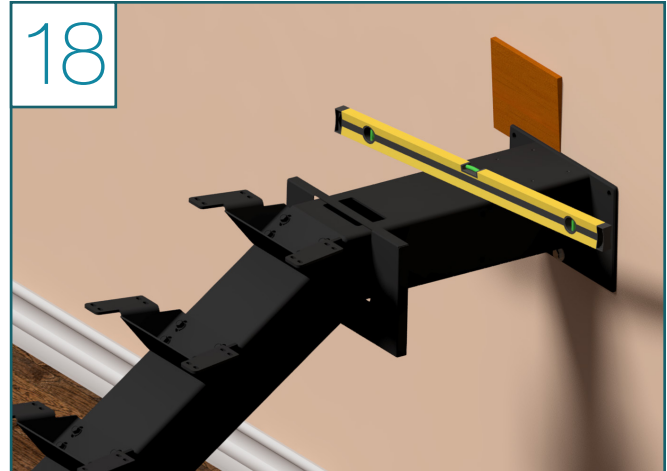

- If not level left to right, shim the header plate to adjust
- If not level front to back, shim the footer plate to adjust
- Cut the excess shim away
- Predrill through the header plate holes with a $\frac{3}{8}$ " drill bit
- At this point, predrill all your header plate holes using a $\frac{1}{2}$ " bit

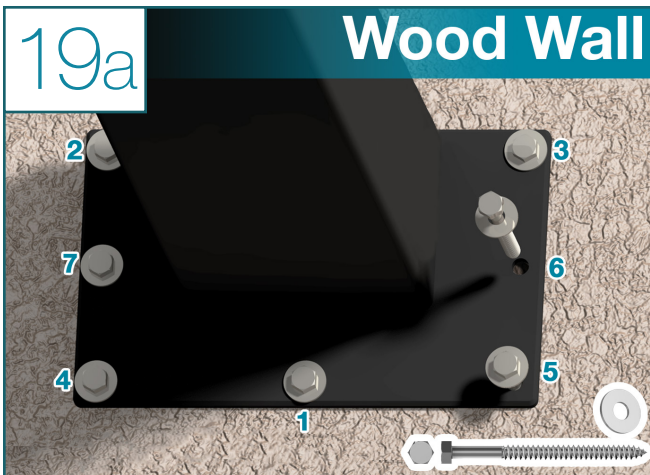

Stringer Wall Mount

- Thread the $\frac{1}{2}$ " x 8" hex head bolts into place

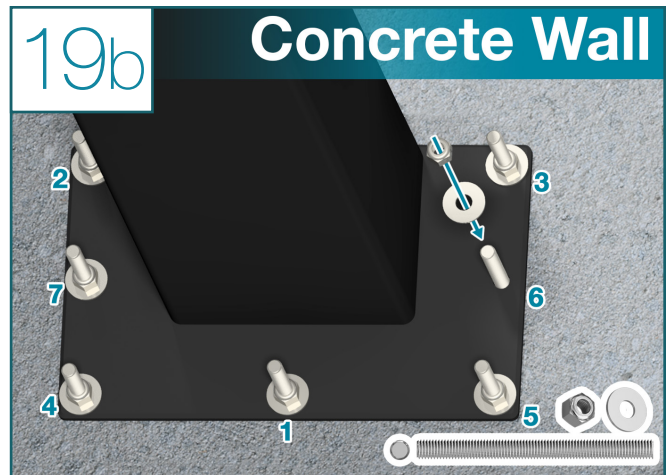

Stringer Wall Mount

- Refer to the recommendation of the brand of epoxy you are using and predrill the correct sized holes for these $\frac{1}{2}$ " threaded studs
- Apply concrete epoxy in to the holes
- Insert the threaded studs into each hole
- Allow for the appropriate amount of curing time, for the epoxy, based off of the manufactured recommendations

Straight Hockey Stick Stringer Installation Steps (Continued)

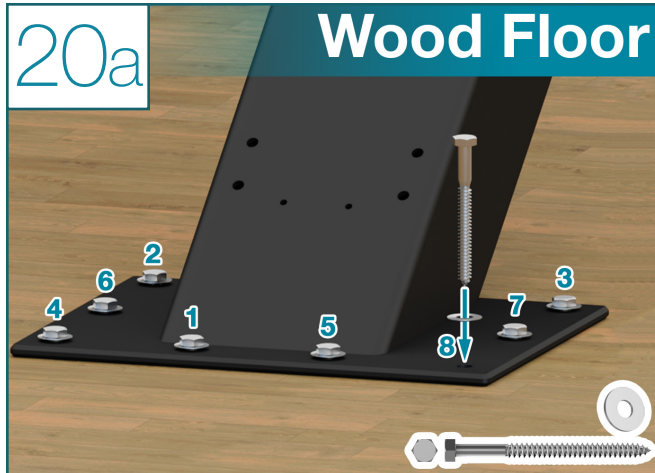

Stringer Floor Mount

- Predrill your footer plate holes with a $\frac{3}{8}$ " drill bit
- Thread the $\frac{1}{2}$ " x 5" head lags into place

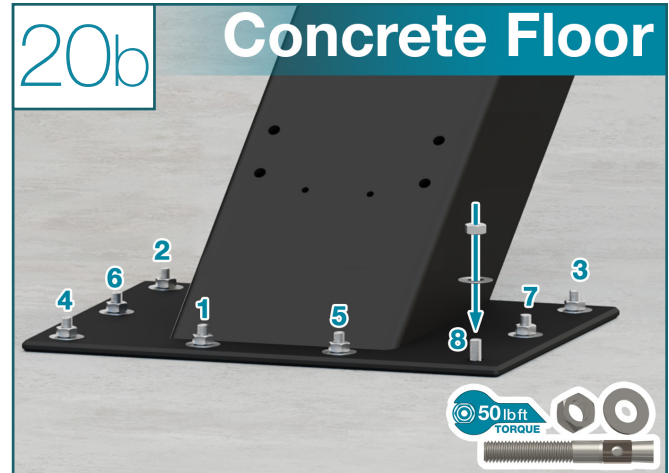

Stringer Floor Mount

- Drill $\frac{1}{2}$ " holes for the concrete wedge anchors
- Insert a concrete wedge anchor into each hole
- Torque to 50 lb-ft

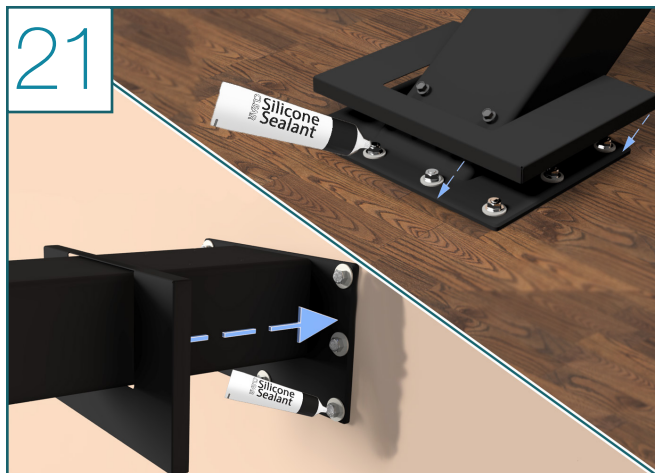

Upper Bracket Cover Installation

- Apply silicone sealant to the tops of the lags
- Carefully slide the cover over the wall plate

Lower Bracket Cover Installation

- Locate the lower bracket cover
- Apply silicon sealant to the tops of the lags or mounting hardware and install cover

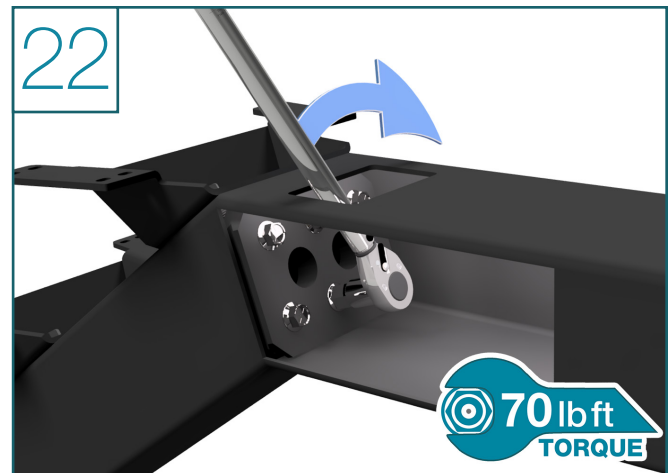

- Using a Torque Wrench, tighten the internal stringer connection bolts, that you installed in Step 4
- Torque to 70 lb-ft
- Do this for all internal stringer connections

Straight Hockey Stick Stringer Installation Steps (Continued)

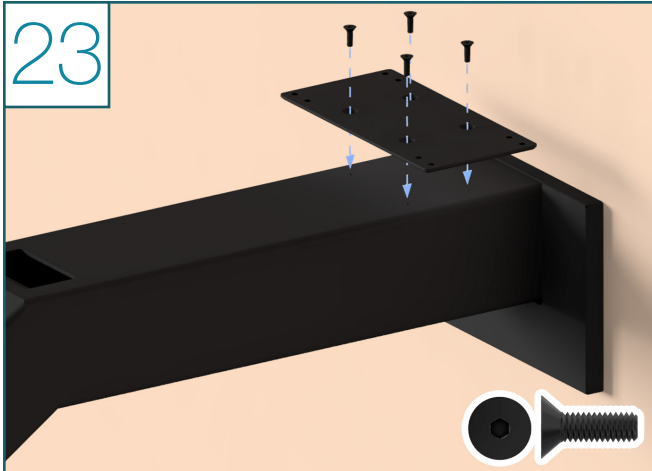

- Using $\frac{5}{16}$ " - 18 x 1" mount & attach the Landing Plates

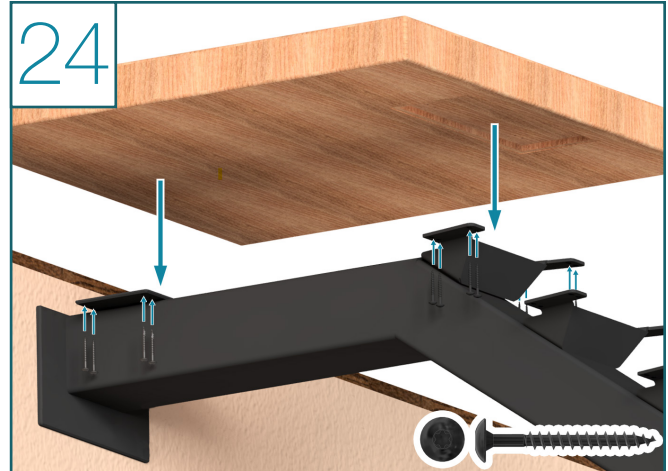

- Position the landing making sure that the platform lines up with the tread bracket and landing plates
- Using the $\frac{5}{16}$ " x 2 $\frac{1}{2}$ " RSS Screws, attach the platform to the landing plates
- During this step, alternate sides of the bracket when fastening screws. This will prevent the tread from pulling unevenly

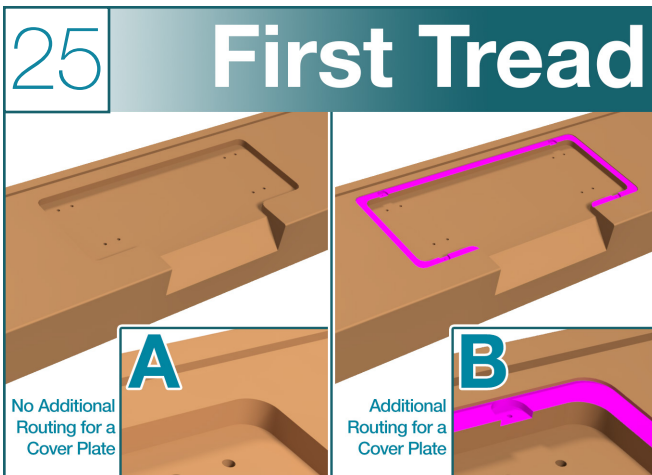

- Identify the first tread by comparing the labels on the bottom of each to the Wood Install Sheet in the front of this packet
- Compare your first tread to the graphic above
- If your tread looks like **Fig. A**: Continue to the next step
- If your tread looks like **Fig. B**: Skip the next 2 steps



THIS STEP IS ONLY FOR FIRST TREADS WITHOUT EXTRA ROUTING (FIG. A)

- Using the $\frac{5}{16}$ " x 2 $\frac{1}{2}$ " hanger bolts, populate the first tread holes
- Mount the first tread on to its tread plate
- The first tread mounts differently to the tread bracket than the rest of the treads

Straight Hockey Stick Stringer Installation Steps (Continued)



**THIS STEP IS ONLY FOR FIRST TREADS
WITHOUT EXTRA ROUTING (FIG. A)**

- Using a nut, tighten the tread to the tread bracket

- Repeat Steps 15-17 to fasten the remaining treads, one at a time, onto the tread brackets

First Tread (Step 25 Fig B)

- If your tread looks like **Fig B** in Step 25, it will install similar to the rest of the treads
- Due to the space constraint that will exist between the bottom of the first tread and the flooring, you will need to use a socket wrench & the provided Torx socket to drive the (4) $\frac{5}{16}$ " x $2\frac{1}{2}$ " RSS screws

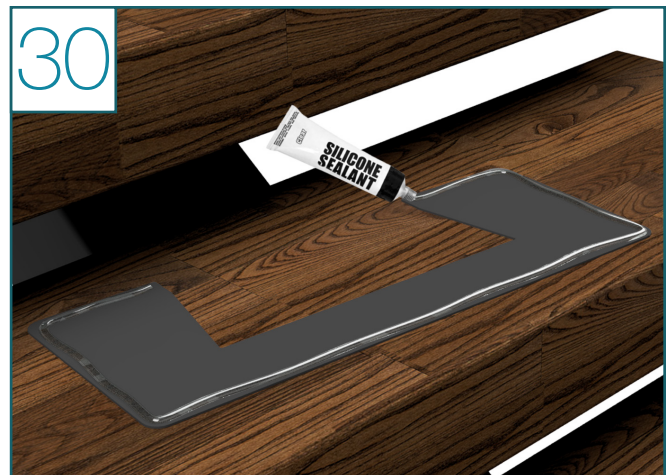
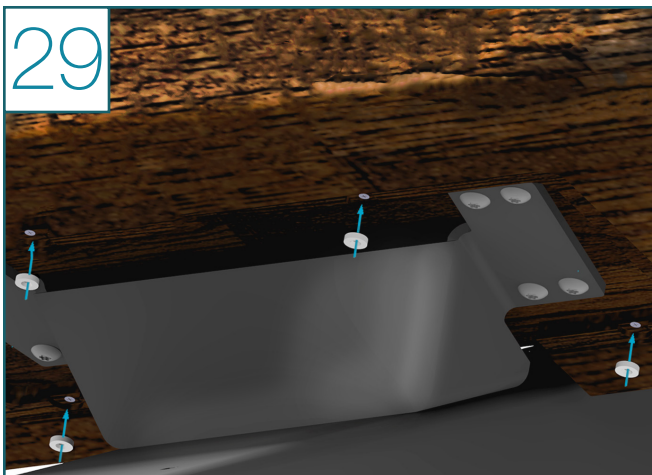

- Once your treads are in place, locate the tread bracket cover magnets and place all 4 magnets on the head of the magnet screws which are already factory installed (LED Treads will have 8 magnets)

Note: The magnets are strong enough to stick to the head of the screw and hold the tread bracket cover while the silicon (next step) dries.

- The first tread will not typically receive a bracket cover and will not have the additional routing

- Next find your tread bracket covers and lay them out.
- Locate and prep your silicone tube
- Run a bead of silicone around the edge of the tread cover, or the edge of the routed section on the tread, whichever you prefer

Straight Hockey Stick Stringer Installation Steps (Continued)

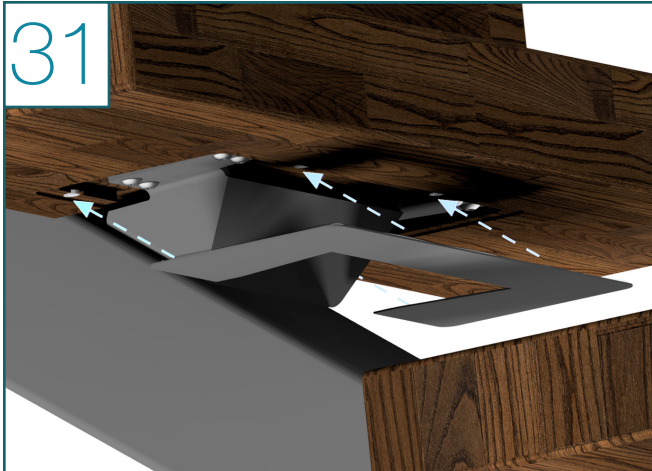

- Set the bracket cover in place. The magnets in the treads will hold the cover tightly, and the silicone will prevent rattling and create a tight fit
- Wipe off any excess silicone that might squeeze out

Congratulations!

You're done with this section.

We'd love to see your work! Snap a few pics with your phone and send them to pictures@viewrail.com. Thanks for choosing Viewrail. Enjoy your new installation!